



# J-ELIII SERIES

## Large Size



Electric Servo Drive  
Injection Molding Machine



JSW Hiroshima Plant

# JSW



JSW Injection Molding  
Machinery Division

# Large Size Electric Servo Drive Injection Molding Machine J-ELIII Series —Tomorrow's technology that is the fruits of tradition and advance

JSW, a large injection molding machine pioneer, is a trail blazer developed upon extensive experiences.

Our advanced technology has actualized the excellent performance.

Integration of ecology and technology contributes to dramatic improvements in quality, productivity and economy.

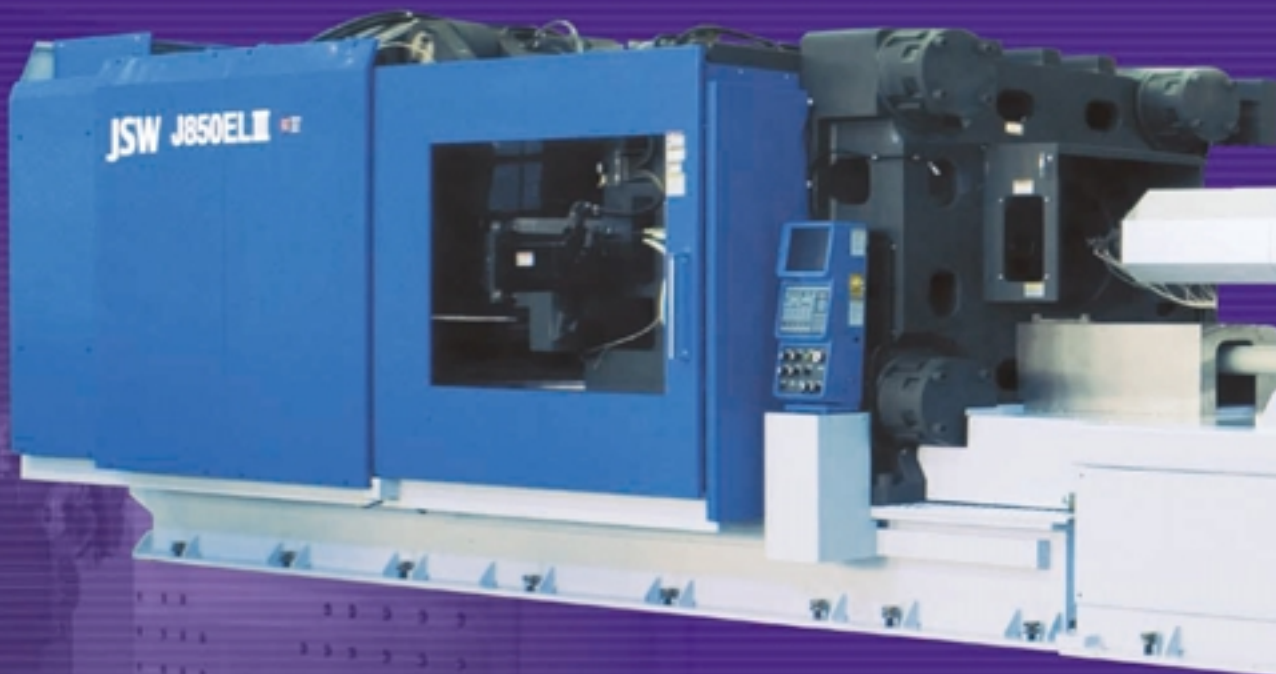

## Excellent high quality stable molding

Extra rigid clamping mechanism  
Powerful output dual-servo injection machine  
High speed and high pressure injection  
High accuracy injection control

## Phenomenal energy savings

Reduced power consumption  
Less cooling water  
No hydraulic oil  
Reduction in equipment cost

# J-ELIII SERIES

## Large Size

## High cycle

High plasticizing rate  
High speed mold open/close and ejector  
High speed mold height adjustment  
High speed dual function

## Functionality

Injection compression molding  
Soft pack servo  
SYSCOM2000 controller  
Easy maintenance



- The appearance and the specifications of the machine may be altered for improvement without notice.
- Unauthorized reprint from this leaflet is prohibited.
- The photographs in this leaflet include options.

# Excellent High Quality Stable Molding

## ■ Extra rigid clamping mechanism

Pursuit of precision steady molding and durability has resulted in 1.2 times rigidity in comparison with the current machine. High rigid clamping ensures superior quality steady molding.

- New design high cycle and rigid toggle system
- Rigid platens designed by FEM analysis
- Large-diameter tie bar
- Movable platen supporting system and long platen guide

Long preservation of mold open/close accuracy and platen parallelism is guaranteed without

Extra rigid clamping platen

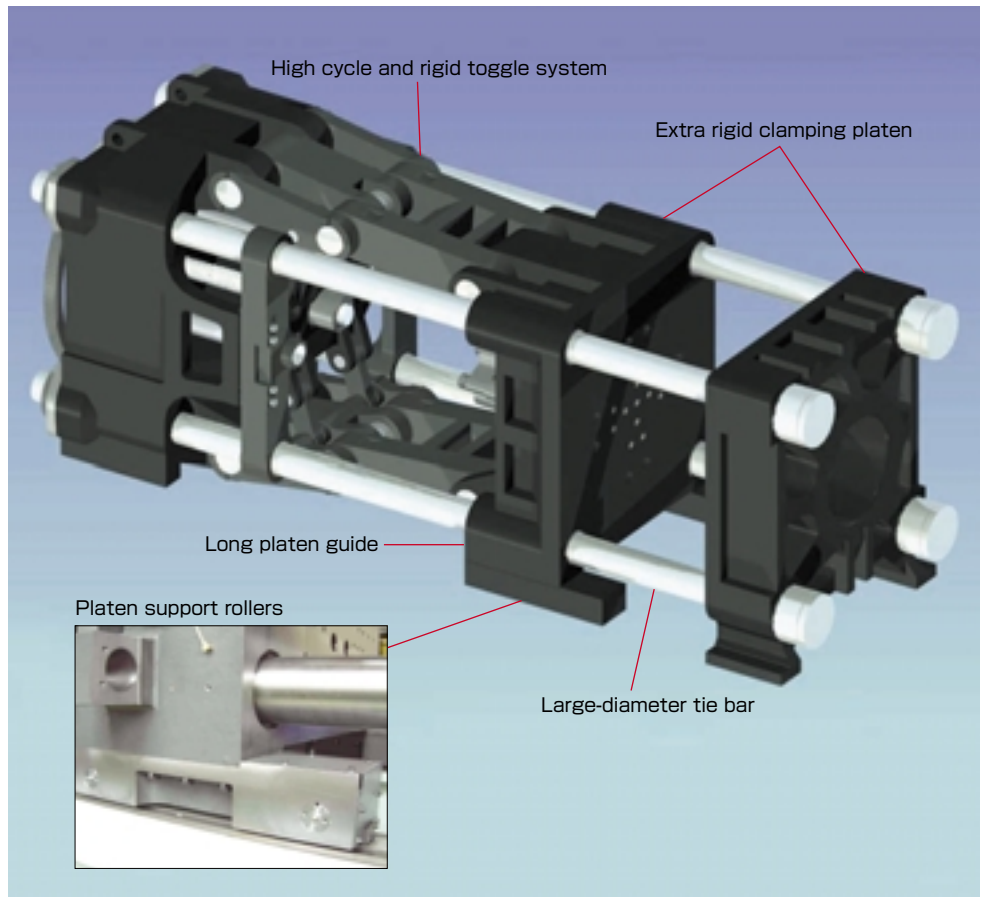
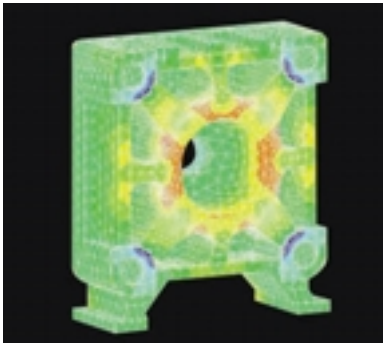

## ■ Powerful dual-servo injection unit

JSW high accuracy dual synchronous control system and rigid injection unit have actualized not only high-speed molding but powerful injection (patent pending).

- Sturdy injection system with plates (3 pcs.) and guide bars (4 pcs.) retaining high durability
- Linear bearing guide ensuring rigid stability and high accuracy

Accurate linear bearing guide

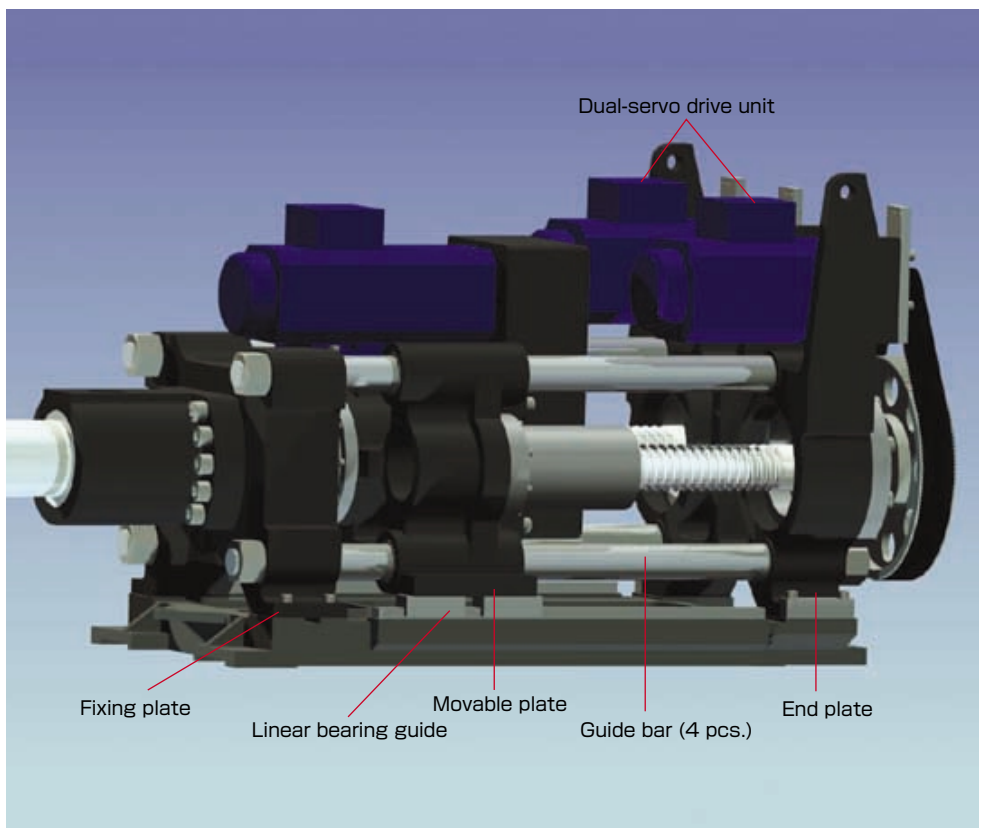
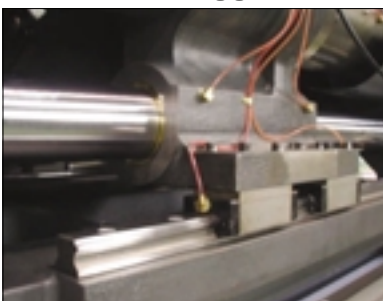

## High speed and high pressure injection

Injection rate becomes 1.8 times faster than the hydraulic machine due to the high speed. Injection pressure also exceeds the hydraulic machine. It realized thin wall molding.

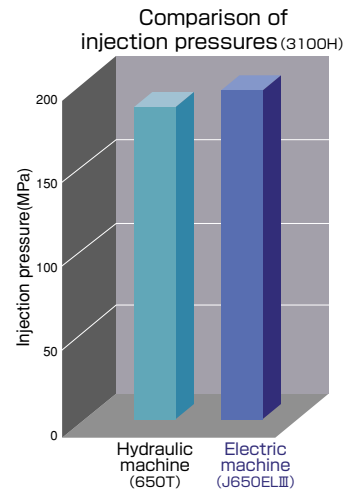
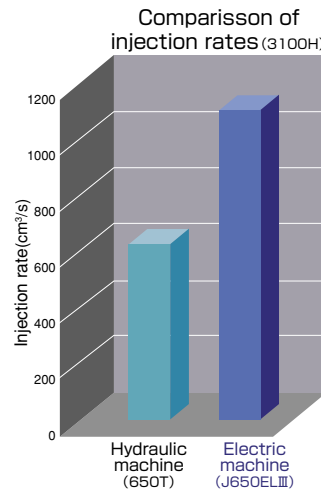
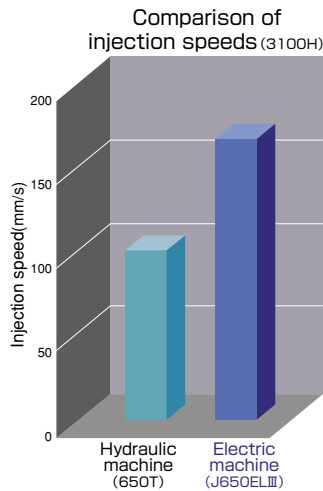

## Accurate injection control

JSW's high performance feedback control (APC control) leads to excellent pressure trackability and responsivity in injection process (Patent No. 3168289).

Holding Pressure Characteristics

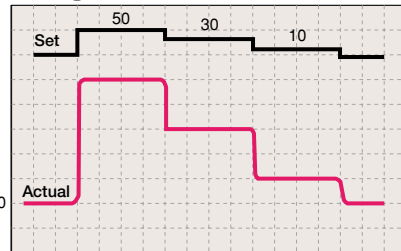

## Advanced Pressure Control

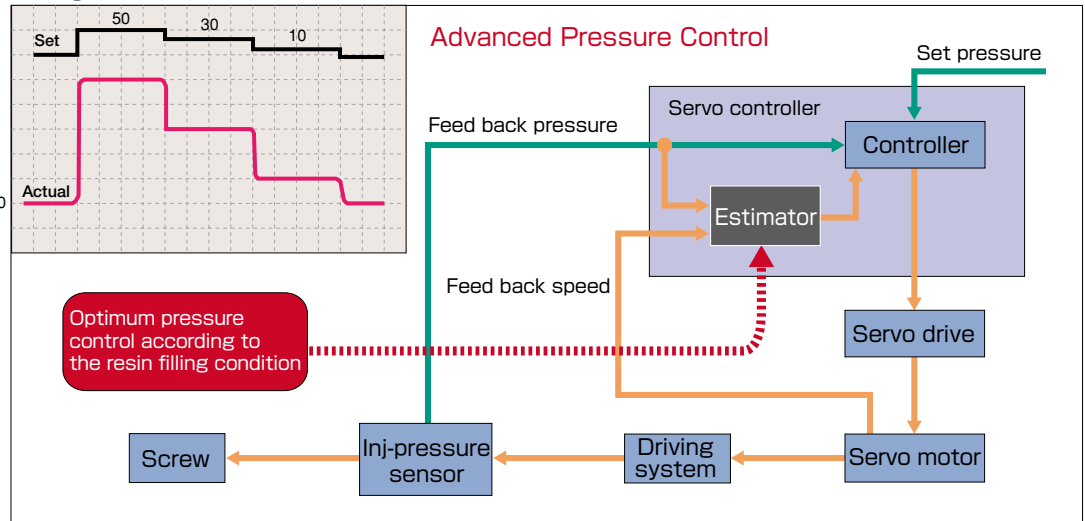

## EX. 1 Weight stability

J-EL<sup>III</sup> molding stability prompts improvements in large molding quality. Weight variations reduced to 1/2 or less of the hydraulic machine

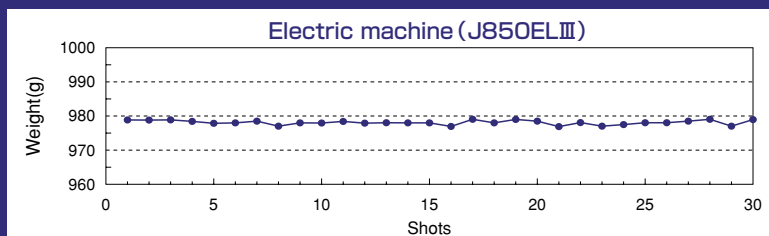
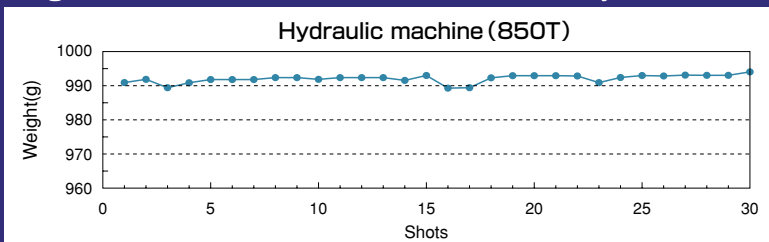

Cycle : 64.7sec  
Resin : PP

	Hydraulic machine (850T)	Electric machine (J850EL <sup>III</sup> )
Average weight ( $\bar{X}$ )	993.0g	978.2g
Max. variation (R)	4.8g	2.2g
Deviation ( $\sigma$ )	1.20g	0.62g
$R/\bar{X}$	0.48%	0.22%
$\sigma/\bar{X}$	0.12%	0.06%

## High performance screw

### High plasticizing capability

Plasticizing becomes 1.3 times better than the hydraulic machine. It reduces the plasticizing time that occupies the cycle time.

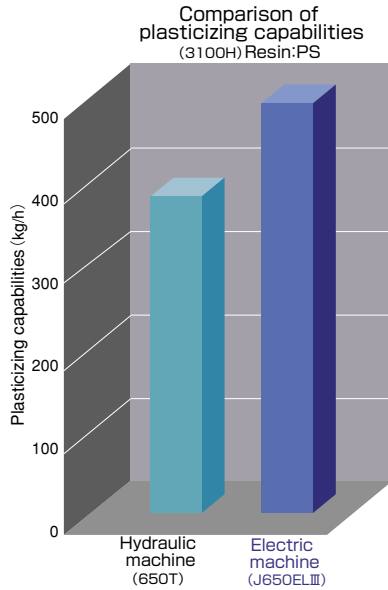

### New high melter MIII screw

Upgraded new high melter MIII screw, with improvement of the current high melter MIII screw, is standard.

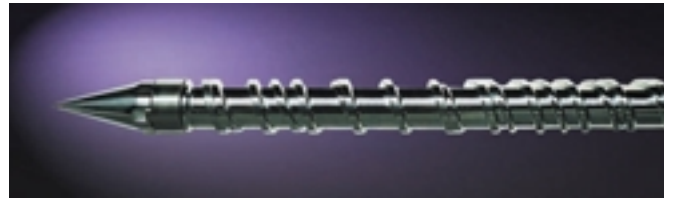

### [Features of new high melter MIII screw]

JSW's dual flight screw with the two sub flights between the main flight

- Reduction in molding distortion due to homogeneous well-kneading
- High speed screw revolution according to high dispersion
- High plasticizing capability by the long screw
- Reduction in cooling time due to low-temperature plasticizing

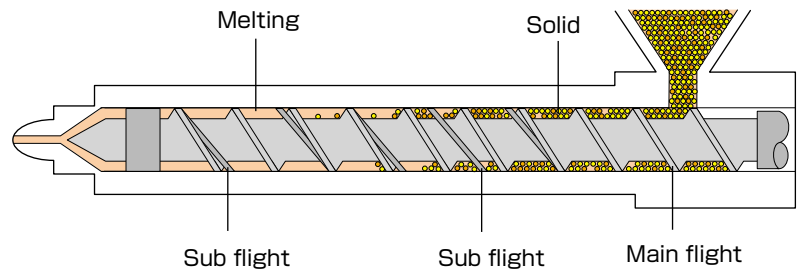

### OPTIONS

Screw development leader JSW provides the wide selection of screws to satisfy user needs.

- High plasticizing capability screw
- Well-kneading and high dispersion screw
- High viscosity resin screw
- Long-fiber resin screw

## High speed mold open/close

High cycle toggle mechanism has actualized high speed mold open/close performance that eventually contributes to 20% reduction in dry cycle.

Accurate platen stop has improvement in productivity, eliminating chuck failure of the take out robot.

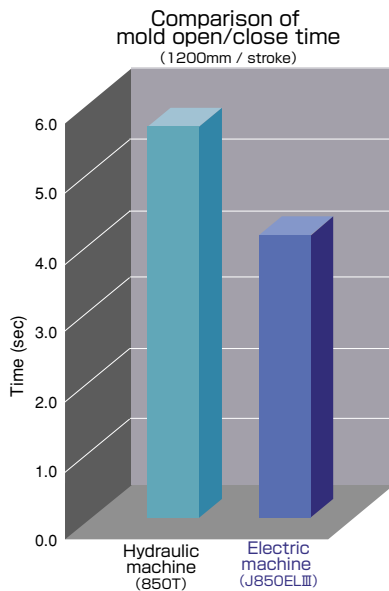

### Comparison of platen stop precision (set at 1200mm)

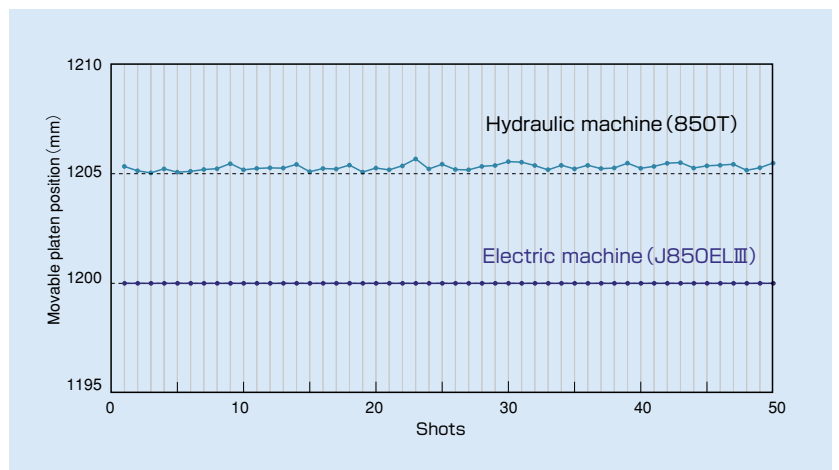

## High speed ejector

Ejector speed has been modified in 1.2 times faster than the hydraulic machine that enables reduction in product removal time.

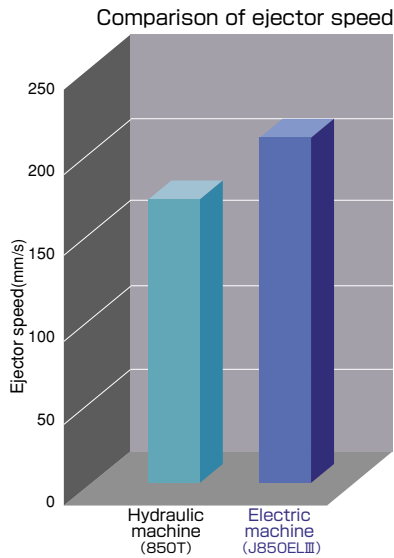

## High speed mold height adjustment

1.5 times faster mold height adjustment has been attained in comparison with the hydraulic system, which allows substantial setup time cutting.

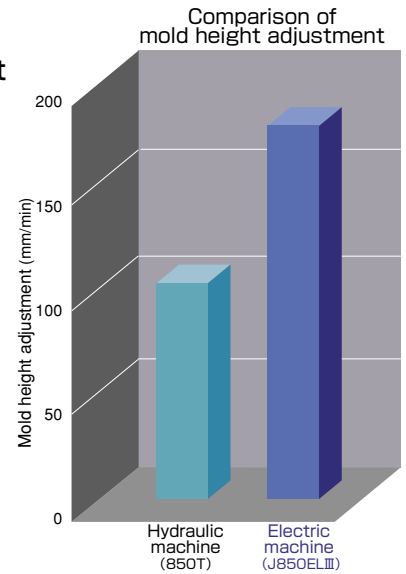

## Ex. 2 Reduced cycle time

Cycle time reduction is available by high efficiency peculiar to J-EL III electric servo machines. High cycle performance completes productivity modification.

Product : OA device body  
 Resin : PPO  
 Qty : 1  
 Weight : 2514g

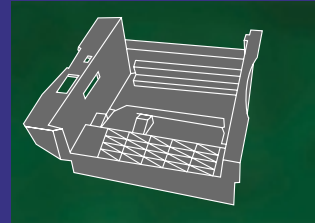

Comparison of cycle time (Standard operation)

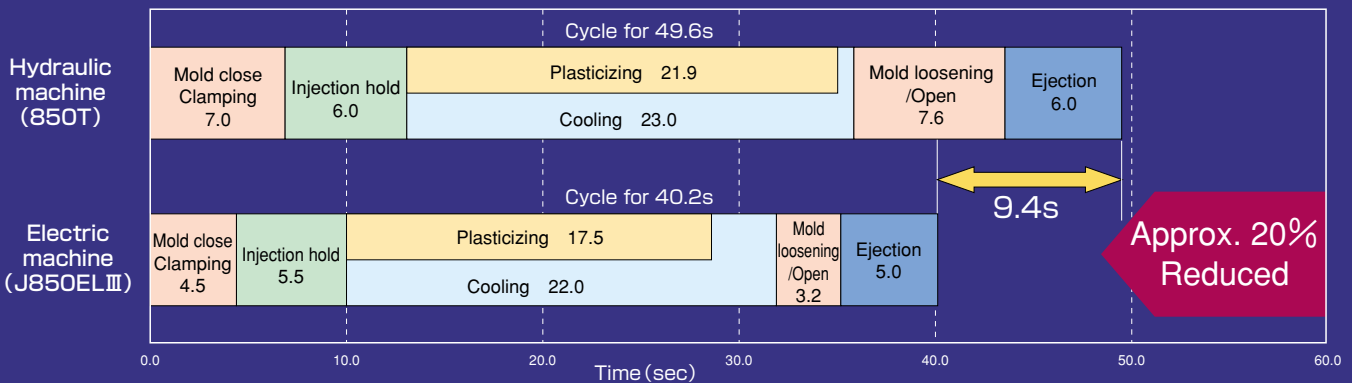

## Further cycle reduction with multifunctional operation

Full use of high speed multifunctional operation function that is actuated by independent drive enables extensive reduction in molding cycle.

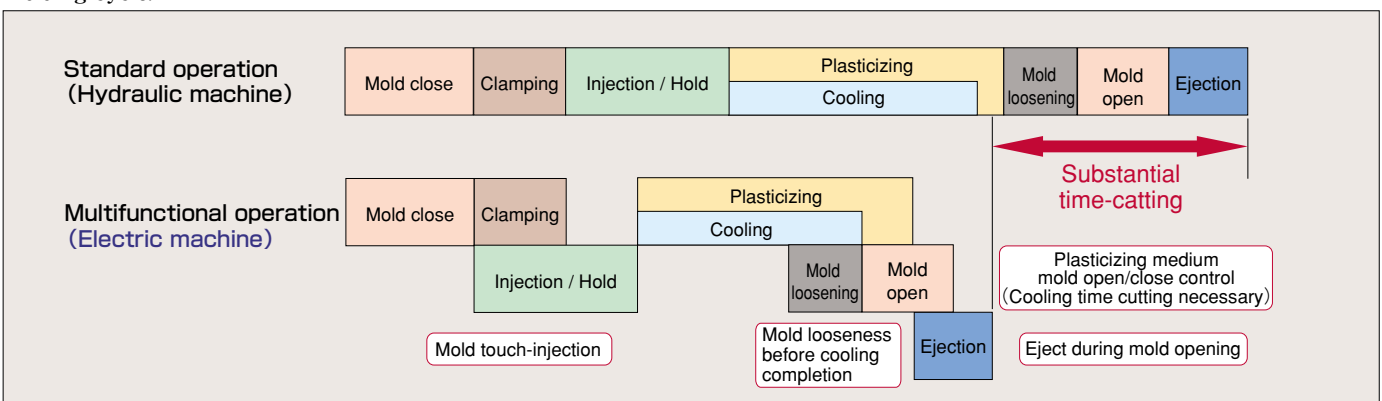

# Phenomenal Energy Savings

## EX. 3 Energy savings

Reduction in substantial energy savings as well as cycle time has been actuated as to J-ELIII large electric series.

- Power consumption is saved by 1/3 to 1/2 of the hydraulic machine
- Cooling water usage saving to 1/5 or less of the hydraulic machine
- No hydraulic oil
- Factory equipment cost is saved (such as the power, cooling water and air conditioning)

Product : Door frame (auto parts)  
 Risin : PP  
 Weight : 960g  
 Cycle : 57s (electric motor)



### Comparison of power consumption

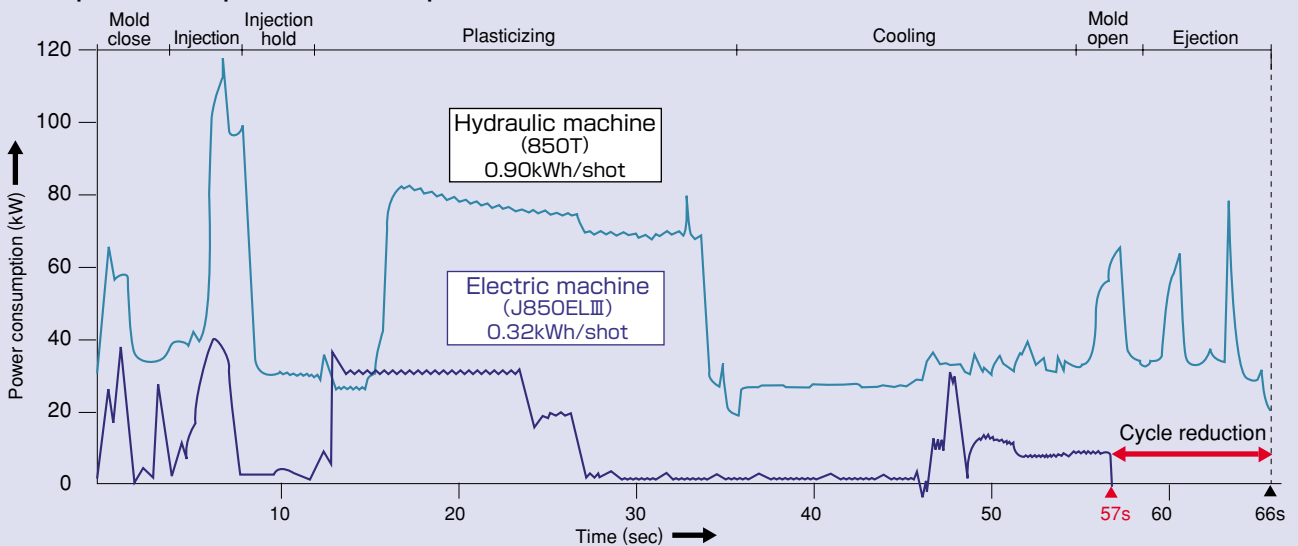

### Comparison of savings

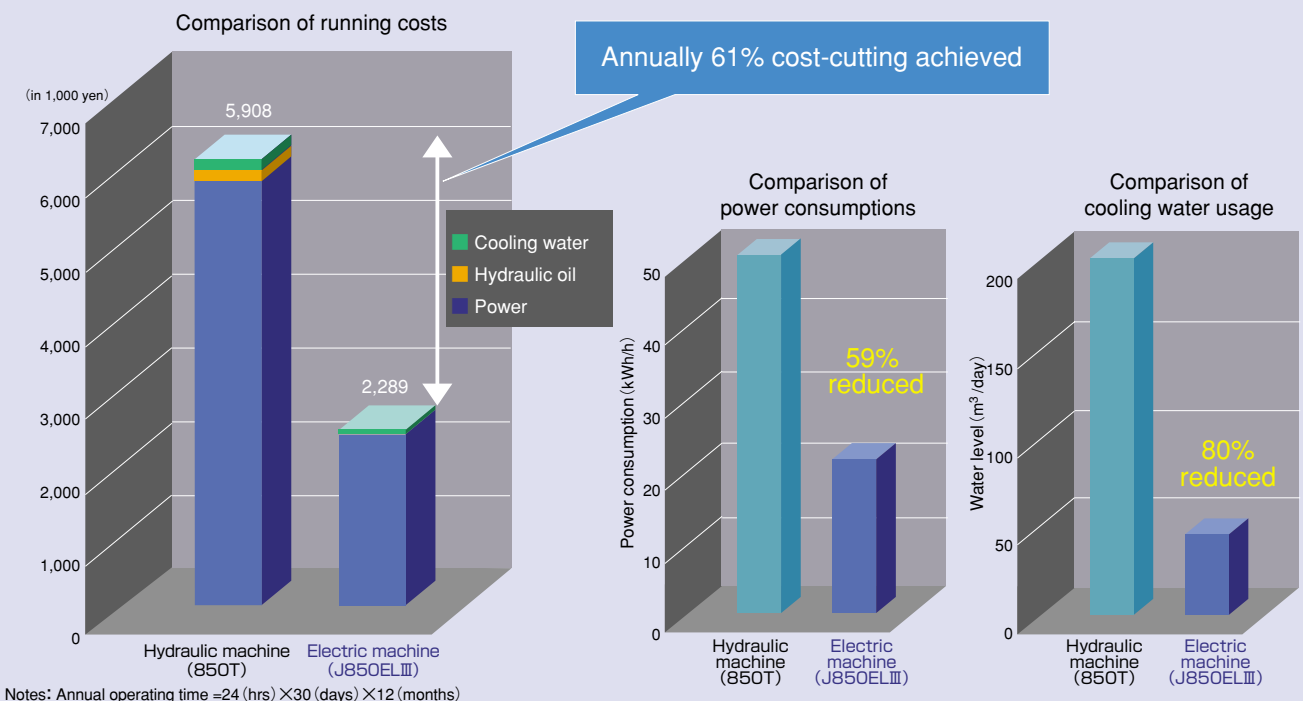

Substantial energy savings offer you enormous economic effects.

## Injection compression molding

### JSW's injection compression molding

(standard equipment: Patent No. 1744469)

Injection compression molding is controlled by high accuracy platen positioning of JSW electric toggle machine. Arbitrary settings of operation mode and pressure level are available for various moldings.

#### Equipment Mode

Equipment modes A and B are available for diverse moldings.

**Mode A**  
A1~A6  
A7 (optional)

**7**  
MODES

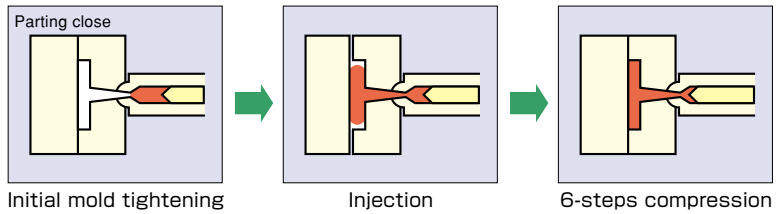

Initial mold tightening

Injection

6-steps compression

**Mode B**  
B1~B3  
[2 modes]

**2**  
MODES

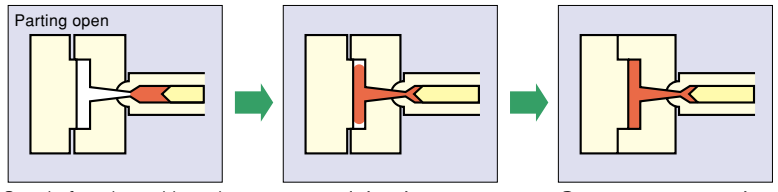

Stop before the mold touch

Injection

6-steps compression

### [Effects of injection compression molding]

- Reduction in molding distortion
- Improvement in transcription
- Easier mold release
- Cycle time reduction
- Gas venting
- Skin adhesion molding

JSW's injection compression molding ensures precision 10 times than the direct pressure molding, which enables mold positioning.

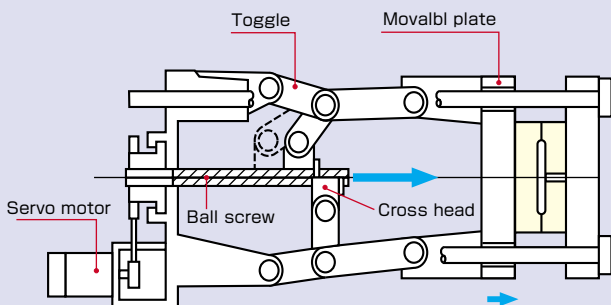

### EX. 4 Effects of injection compression molding

The following effects are to be gained by J-ELⅢ injection compression molding: reductions in molding distortion, cycle time and clamping force.



Product : Roof of doghouse  
Resin : Recycled PP

	Standard	Injection compression (A1 mode)	Effect of injection compression
Distortion	7.5~11.0 mm	0.2~0.5mm	7.0~10.8mm reduced
Cycle time	74.8 sec	56.3 sec	18.5 sec reduced
Clamping force	1300 t	800 t	500 t reduced

## Soft pack servo

### Soft pack servo, proper pressure injection molding

(standard equipment: Patent No. 1755568)

Resin filling at a proper pressure is executed, suppressing the peak pressure immediately before holding pressure changeover in injection process.

Soft pack servo produces effects on over-packing prevention to thin wall molding.

### [Effects of soft pack servo]

- Reduction in molding distortion
- No flash
- Improvement in weight stability
- Reduction in clamping force (low-pressure molding)
- Longer mold life

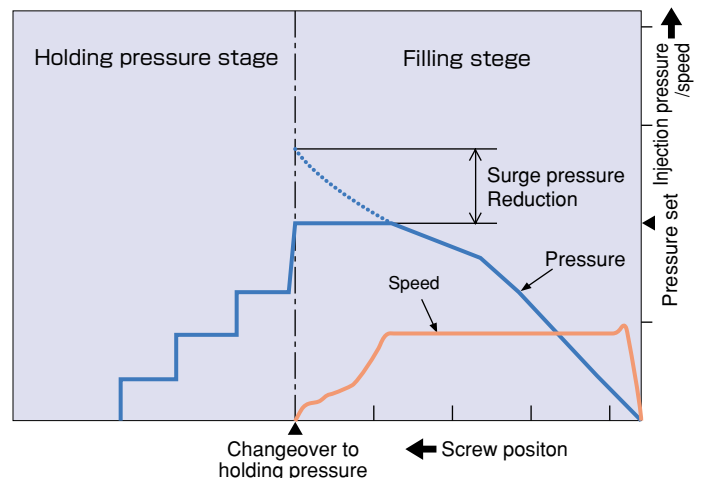

## Operator-friendly interactive controller SYSCOM2000



### ●TFT color LCD with touch panel

Large TFT color LCD provides a clear picture for operator-friendly viewing.

Interactive operation has been actualized with the screen-touch that allows ease of condition settings.

### ●High-touch keyboard

User-friendly design is offered with the mode selections arranged on the illustration of the molding machine, and easy setting prevents misoperation.

### ●Built-in controller

Controller composed of the display and operating keyboard is provided, which is embedded in the local box of the machine center with the least wasted space around the machine that enables all operations.

### ●Memory of molding conditions

40 mold conditions are to be stored in either a data card as well as internal memory.

### ●Language switching function

Language selection is available between Japanese and English in response to the need for internationalization. Adaptable to other languages (optional).

### ■ Overall set up

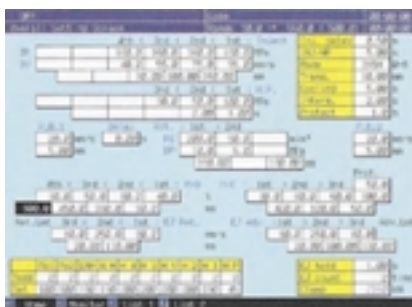

### ■ Injection-compression set up



### ■ Wave form monitoring

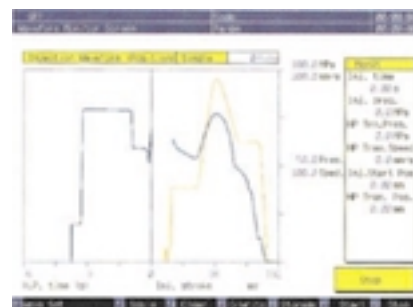

## Easy Maintenance



### ■ Automatic lubrication system

Automatic lubrication system is equipped in the clamping unit and injection unit.

Alarm is to be issued upon the occurrence of greasing error that contributes to substantial improvements in maintenance.

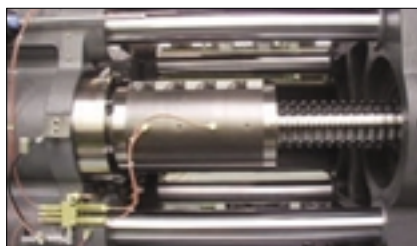

### ■ High endurable ball screw

High endurable ball screws are adopted for high speed and high load.



### ■ JSW original servo amplifier

Large injection machine servo amplifiers, soft and hard, are our developments that enable quick maintenance at any circumstances.

## Standard Equipment

Unit item		
Injection and Plasticizing		
Standard open nozzle		
Screw cylinder	1)	
High-melter MIII screw	2)	
Screw suck back		
Purge cover (with LS)		
Swivel injection unit	3)	
Cold screw start-up prevention		
Molding/Pause temperature changeover function		
Automatic purging circuit		
Sprue break timing selection		
Suck back timing selection		
Injection and rotation program control (Closed-loop control)	Injection speed	1~6
	Injection pressure	steps
	Holding pressure	
	Screw speed	1~3
Screw back pressure	steps	
Transfer to holding pressure by sensing Injection speed (IVS)		
Automatic greasing		
Cylinder temperature control	4)	
Nozzle temperature control (SSR)		
Cylinder temperature remote setting		
Soft pack servo control		
Mold Clamping Unit		
Self-lubricating toggle bushings		
Automatic greasing		
High performance moving platen support		
Remote setting of mold open/close speed		
Remote setting of moving platen position		
Remote setting of ejector speed		
Remote setting of ejector position		
Automatic mold height adjustment		
Remote setting of mold height		
Automatic mold clamping force setting		
Compression molding (1~6 steps)		
Mold protection device		
Safety devices (electrical and mechanical)		
Take-out robot mounting holes		

### Notes:

- 1) N2000F cylinder for 1400H injection unit, and nitride cylinder for 2300H and up.
- 2) GP2 screw for 1400H injection unit.
- 3) Manual operation type for 1400H injection unit.
- 4) Solid state control (SSR) for 1400H injection unit and magnetic contactor control (MC) for 2300H and up.
- 5) The printer, printer cable and receptacle are optional.
- 6) The Japanese/English switching function is standard equipment.
- 7) Sensor and cable are not included.

## Optional Equipment

Unit item	
Injection	
Long nozzle	
SVN shut-off nozzle (spring type)	
Wear and corrosion-resistant cylinder	
Wear and corrosion-resistant screw	
Wide selection of screws	
Cylinder heat insulating cover	
Cylinder cooling unit (with blower)	
Shut-off nozzle (hydraulic or pneumatic)	
Hopper	
Hopper stage	
Mold Clamping Unit	
Daylight extension	
T-grooved platen	
Spacer plate	
Air jet	
Core puller circuit (hydraulic or pneumatic)	
Unscrewing motor control circuit	
Gate-cut circuit	
Automatic opening safety door	
Automatic opening and closing safety door	
Special locating ring	
Safety mat switch	
Cooling water closed circuit (stationary platen type)	
Ejector plate return confirmation circuit	
Mold mounting preparation unit	
Controller and Others	
Abnormal mold temperature warning	
Hot runner control circuit	
Language switching function	11)
Alarm light	
Communication function with host computer	
Printer (with printer cable)	
Printer cable (IBM compatible)	
Data card (40 sets mold/card)	
Calendar timer	
Plug socket for auxiliary equipment	
Levelling pads	

- 8) Setting of production quantity and advance notice are possible and completion time is displayed.
- 9) Monitoring functions of the following particulars are equipped as standard. (Cycle time, Injection time, Rotation time, Mold opening-closing time, Cushion, Injection start position, Changeover position to holding pressure, Injection pressure, Changeover pressure to holding, Screw back pressure)
- 10) Maintenance service time and areas are displayed.
- 11) One more language can be added, in addition to Japanese and English.

## J-ELIII Large Size Electric Servo Drive : Module System [Wide Selection]

